









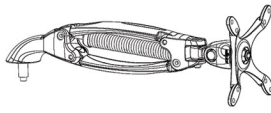

 4 x  4 x 	3 – 5 kg	818.11.974	818.11.374
	5 – 7,5 kg	818.11.975	818.11.375
 1 x  4 x  4 x 	3 – 5 kg	818.11.942	818.11.342
	5 – 7,5 kg	818.11.952	818.11.352
 1 x  4 x  4 x 	3 – 5 kg	818.11.903	818.11.303
	5 – 7,5 kg	818.11.932	818.11.332
		818.11.915	818.11.315
		818.11.914	818.11.314
		818.11.980	818.11.380

Zusätzlich benötigte Werkzeuge:
 Additionally required tools:
 Outils supplémentaires nécessaires:
 Herramientas adicionales necesarias:

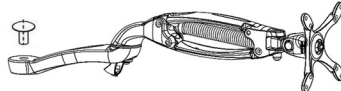

Ø 55 mm

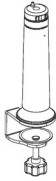

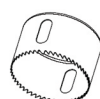
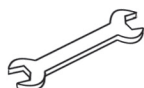
SW 8

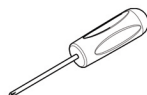

8 mm

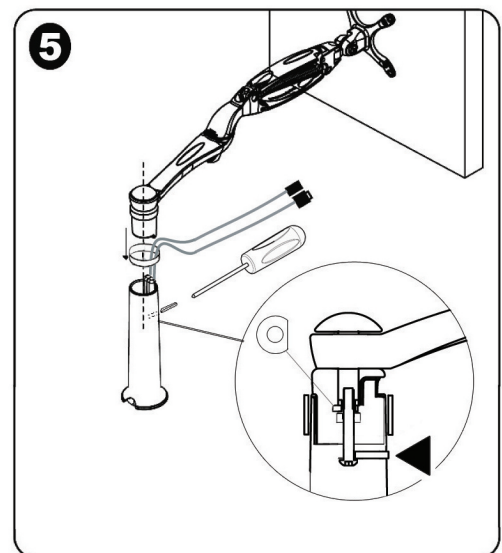
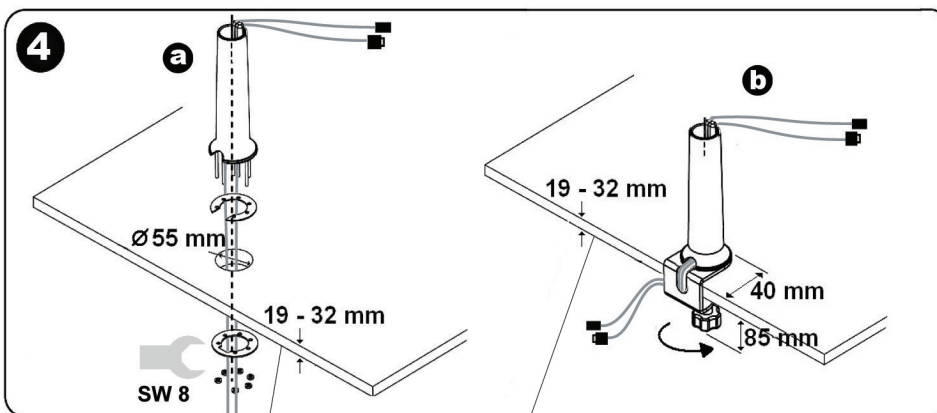
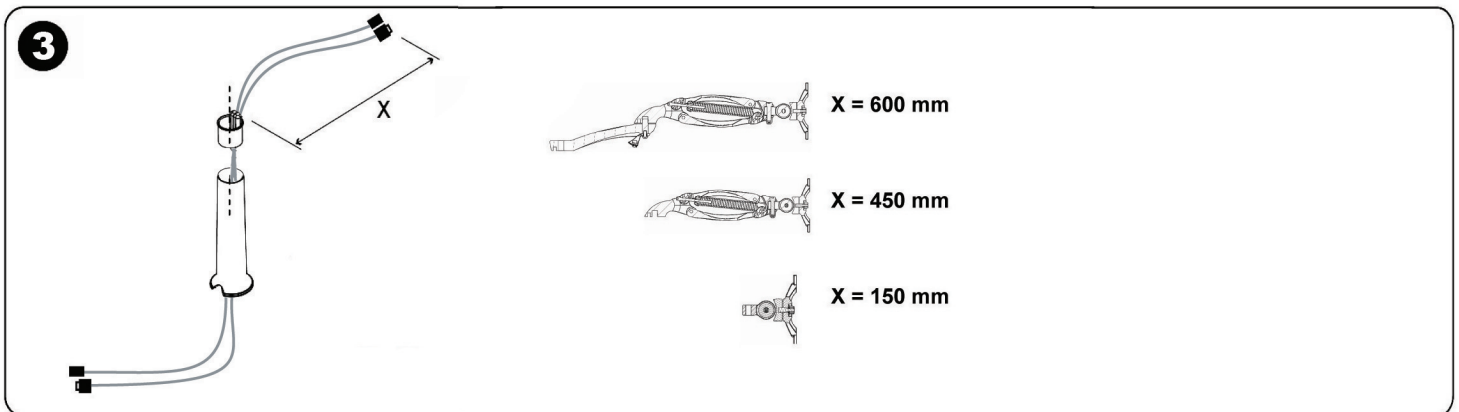
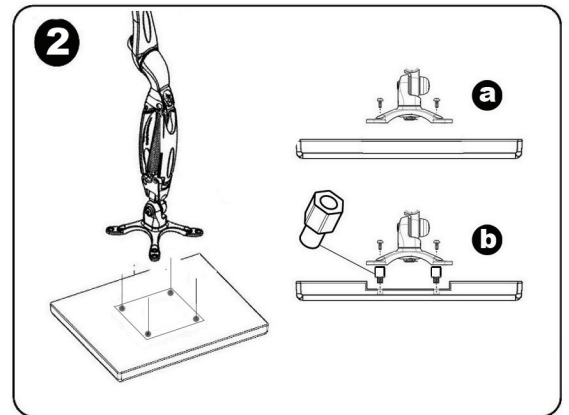
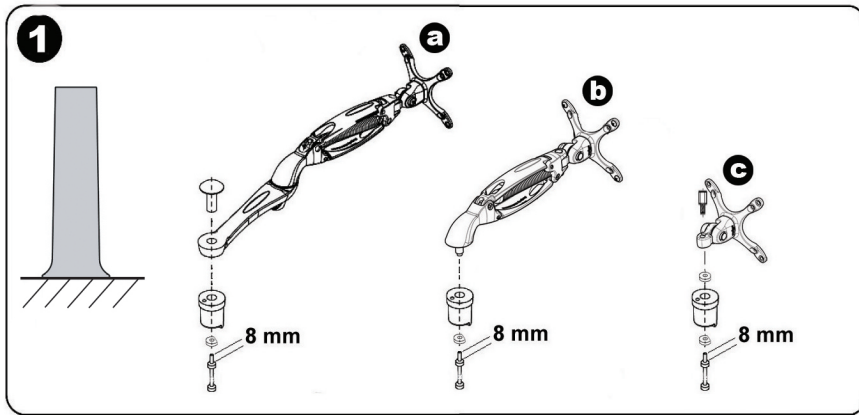

Verwendbares Arbeitsplattenmaterial: Massivholz, Spanplatte, Tischlerplatte, MDF
 Worktop material used: solid wood, chipboard, block board, MDF
 Matériau pour plan de travail utilisable : bois massif, panneau d'aggloméré, panneau latté, MDF
 Material utilizado para encimera: madera maciza, tablero aglomerado, tablero de carpintería, MDF

